

TS8200D Series

Micro-Meter Mix Spare Parts Guide

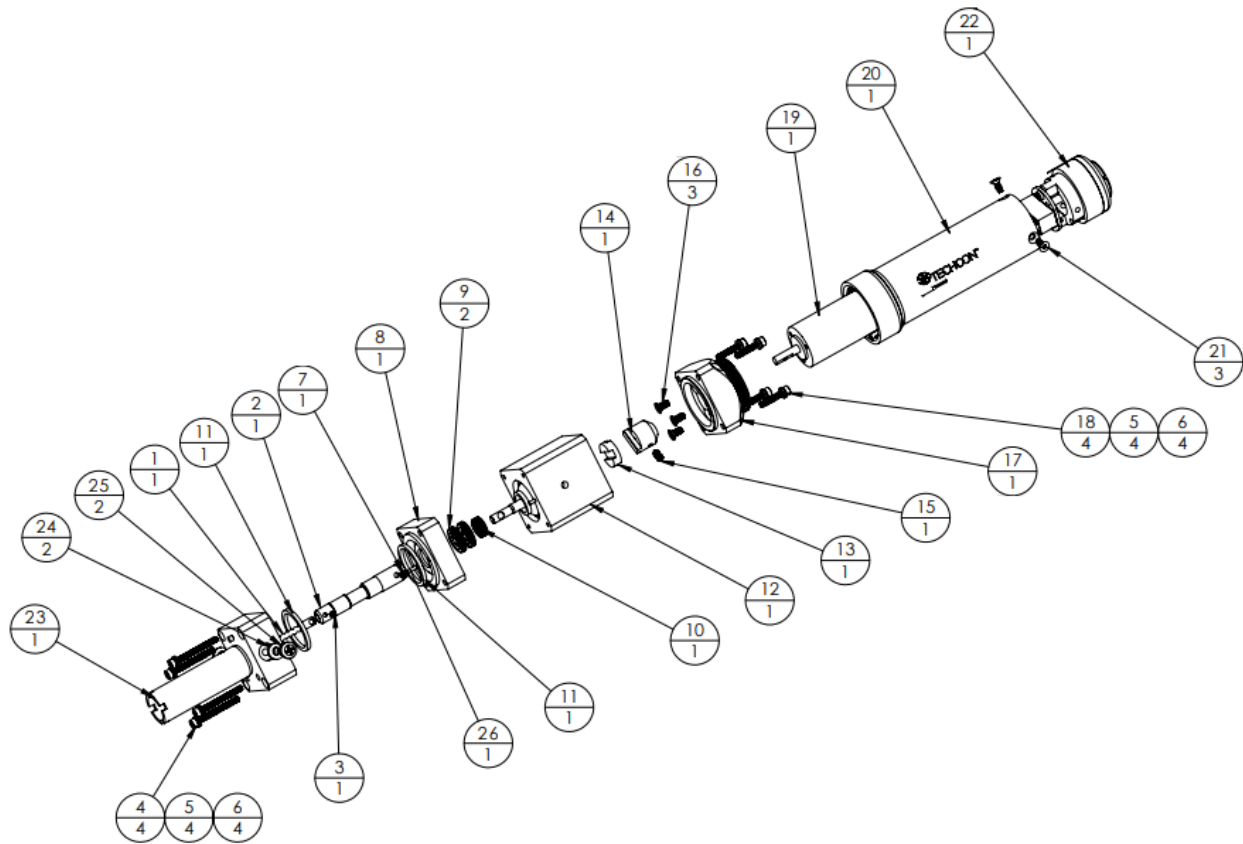

TECHCON



Item #	Part Number	Description	Item #	Part Number	Description
1	8100-100-001	Rotor 2.5 mm Pitch (100 Series)	13	7509-0960	Coupling Disc
	8100-200-001	Rotor 5.0 mm Pitch (200 Series)	14	7509-0950	Coupling Half Top
	8100-300-001	Rotor 6.5 mm Pitch (300 Series)	15	2800-0903	Set Screw, M3 x 0.5mm x 6MM LG, S.S
	8100-400-001	Rotor 9 mm Pitch (400 Series)	16	2800-0901	Screw, M3 x 6mm LG, FH, PHIL, MACH, S.S
	8100-500-001	Rotor 10 mm Pitch (500 Series)	17	7509-0980	Motor Mounting Plate
2	7509-9430	Flex Coupling (100-400)	18	2800-0897	Screw, M2.5 x 14mm LG SHC, S.S
	7509-9470	Flex Coupling (500)			

TS8200D Series

Micro-Meter Mix Spare Parts Guide



3	2800-0836	Set Screw, M2.5 x 3mm LG, Socket, Cup, S.S	19	2600-0185	Motor, 24 VDC, Encoder, 83:1 Gear Reduction
4	2800-1019	Screw, M2.5 x 25mm LG, SHC, S.S	20	7509-0340	Motor Cover
5	2800-0295	Washer, M2.5, Lock, Medium, S.S	21	2800-0900	Screw, 4-20 x 1/4" Thread Forming, S.S
6	2800-0917	Washer, #4, 0.115 IDx0.209 OD, 0.024 THK, S.S	22	7509-9400	Assy, Motor Connector
7	2800-0688	Set Screw, M3 x 4mm LG, S.S	23	7509-1450	Stator Housing (100-300)
8	7509-0970	Shaft Seal Block		7509-1570	Stator Housing (400)
9	7509-0990	Shaft Seal		7509-1560	Stator Housing (500)
10	3300-0353	Cup Seal, UHMW Jacket, S.S Spring	24	3300-0696	Vent Seal, Washer, #8-.15" ID x .31" OD x.52 THK, Fluorosilicone
11	3300-0690	O-Ring, Square, 3/4" ID x 7/8" OD X 1/16 W, BUNA N	25	2800-0431	Vent Screw, M4 x 8mm LG, PAN PHIL, MARC, S.S
12	7509-9340	Bearing Block Assembly, FA	26	3300-0595	PIN, DOWEL, M1.5 DIA x 5mm LG, S.S

Pump Motor Cables

Part Number	Description
8200D-000-002	Cable Assembly, PC Pump

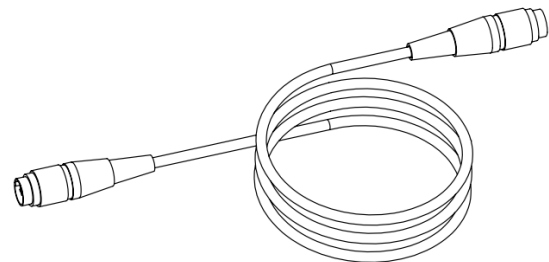

Pump Housing and Manifold Assembly

Part Number	Description
7509-1460	Pump Housing
7509-1150	Fluid Manifold, K-type Nozzle 1:1
3300-0656	GASKET, 1/2" ID X 5/8" X 1/16 W, VITON
7509-1190 3300-0662	Fluid Manifold, Plug Screws Plug Screw O-rings, 3mm ID x 1 mm CS, EPDM

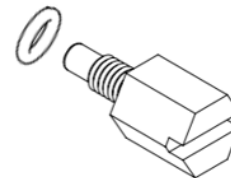

Stators

Part Number	Description
8100-100-002	100 Series
8100-200-002	200 Series
8100-300-002	300 Series
8100-400-002	400 Series
8100-500-002	500 Series



Output Port Adaptors

Part Number	Description
8200D-000-001	<p>Calibration Adaptor Assembly</p> <p>Includes:</p> <ul style="list-style-type: none"> -x1 7509-1210 Calibration Adaptor -x2 3300-0662 O-rings, 3mm x 1mm CS, EPDM -x2 2800-1030 Captive Screws
7509-1160	1:1/2:1 K-Type Nozzle Locking Plate
8200D-000-006	<p>4:1/10:1 K-Type Nozzle Adaptor</p> <p>Includes:</p> <ul style="list-style-type: none"> -x1 7509-1170 K-Type Nozzle Adaptor -x2 3300-0662 O-rings, 3mm x 1mm CS, EPDM -x2 2800-1033 Screws, M3 x 6mm, SHC, S.S
8200D-000-005	<p>Bayonet Adaptor</p> <p>Includes:</p> <ul style="list-style-type: none"> -x1 Bayonet Adaptor -x2 Screws, M3 x 10mm, SHC, S.S -x2 3300-0662 O-rings, 3mm x 1mm CS, EPDM



Syringe Bracket

Part Number	Description
TS8200D-SYBRACKET	<p>Syringe Bracket for Syringe Barrels</p> <p>Includes:</p> <ul style="list-style-type: none"> -x2 Syringe Holder, 30/55cc -x2 Syringe Holder adaptors, 10cc -x2 Syringe Holder adaptor, 6cc -x2 Syringe Holder adaptor, 3cc

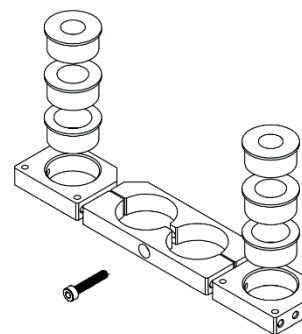

Mounting

Part Number	Description
2800-1031	Mounting Screws, M4 x 35MM, SHC, S.S
7506-0280	Mounting Bracket (for TSR robot)

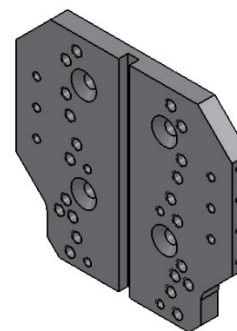

Cleaning Kits

Part Number	Description
8200D-CLEANKIT	<p>Cleaning Kit</p> <p>Includes:</p> <ul style="list-style-type: none">- x1 TSD2106-1, Cleaning Brush, Small, 0.15" (3.8mm)- x1 Cleaning Brush, Large, 0.45" (11.4mm)- x1 Wrench, Hex L-key, 1.5mm x 1-3/4"- x1 Wrench, Hex L-key, 2.0mm x 1-57/64"- x1 Wrench, Hex L-key, 1.3mm x 2-13/16"- x1 Wrench, Hex L-key, 3.0mm- x4 7509-0990, Shaft seals- x2 3300-0353, Cup Seals- x4 3300-0696, Vent Seal Washers

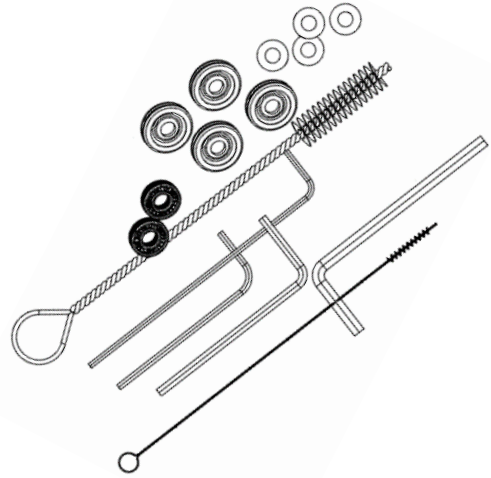

TS8200D Series

Micro-Meter Mix Spare Parts Guide



TECHCON™

Optional Accessories

Part Number	Description
8200D-PS	Pressure Sensor



Part Number	Description
8200D-SEALKIT	Seal Kit Includes: - x2 Gasket, 1/2" ID X 5/8" X 1/16 W, VITON - 2x Cup Seal, UHMW, S.S.Spring, TS7000 - x4 Shaft Seal - x4 O-Ring, Square, 3/4" ID X 7/8" OD X 1/16 W, BUNA N - 4x Washer, #8-.15" ID X .31" OD X .52 THK, Fluorosilicone
7305XCON	Cleaning Conditioner, 30cc

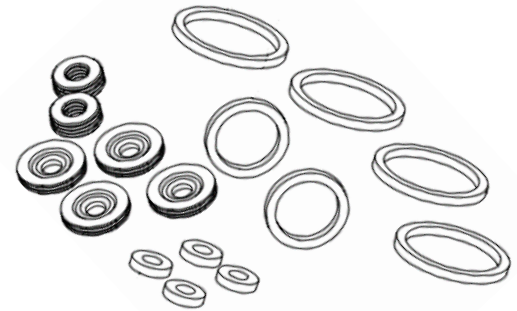

**For Sales
and Support:**

Techcon Corporate Headquarters
10800 Valley View Street
Cypress, California, 90630, USA

Tel: 1-714-799-9910 | Fax: 1-714-828-2001
E-mail: oemorders@okinternational.com

Visit our website for more information and to contact the Techcon office nearest you. We have several offices worldwide that are ready to serve your needs.

techcon.com/contact-us